



Watching Video

Concrete Pump / Boom Pump

# ECP53CS-5

## Boom Type

5 section RZ folding

## Vertical Reach

53m

## Horizontal Reach

47.9m

## Depth Reach

38m

## Delivery Pipe Diameter

125mm

## Slewing Range

360°

## Outrigger

Swing-type (Front)

Swing-type (Rear)



**EVERDIGM**

# FFH SYSTEM (Free Flow Hydraulic)

This type of FFH Hydraulic Pressurized Systems combined with **Rexroth**® pumps and **Hawe**® boom control block is widely recognized to all over the world due to efficiency and stability. Currently Everdigm Pumps are applying these systems for longtime and widely known and also proven the products to everyone. Based on these facts FFH systems are used all over the world and mostly welcomed. Efficient pumps, less boom bouncing and less noise for while it operates. As above all, these reasons they are providing comfortable working area.

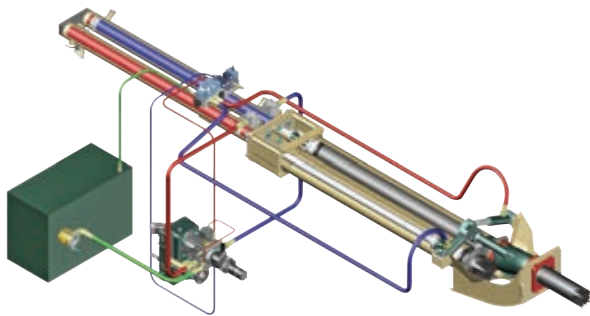

---

Direct connecting main pump and hydraulic cylinders  
improve pumping efficiency

---

Less peak pressure & less boom bouncing by peak  
pressure control

---

No need of big oil tank

Cut down maintenance cost

---

Applying suction filter

Prevent contamination in main pump

---

Centralized pumping controller

Easy access and maintenance

---

## FEATURES

### PUMPING UNIT

---

Closed-loop Free Flow Hydraulic System

Inductive Proximity Switch and Indicator

Single Lip Concrete Piston

Hard-Chromed Concrete Cylinder

---

### BOOM & STRUCTURE

---

5 Stage RZ-Folding Boom

Swing Front Outrigger (Two Stage)

Swing Rear Outrigger (One Stage)

Outrigger Pilot Check Valves

Hyd. Motor and Gear Type Boom Slewing

High Pressure End Hose (3m)

Boom & Deck Pipe Diameter 125mm

Greasing Port on Boom Link and Pedestal

Bubble Gauge on Both Side

Water Pump, Water Tank, Cleaning Hose and Spray Nozzle

Working Light on Pedestal and Platform

---

### HOPPER

---

Easy Clean Type Hopper

Hi-Manganese Agitating Paddle

600 Liter Volume Hopper

Hopper Outlet Diameter 180mm

S2018 Type S-tube (Dia.200-180mm)

Flap Elbow (Dia.180-150mm) with Cleaning Port

Reducing Pipe (150-125mm)

Tungsten Carbide Wear Ring and Plate

Hydraulic Agitator Motors on Both Side Hopper

Auto Lubrication

Working Light on Hopper

---

### CONTROL KIT

---

Wire Remote Control (40m Cord)

Wireless Remote Control (Proportional)

Remote ON/OFF Pumping

Remote ON/FF Engine

Infinite Variable RPM Control

Boom Control Block

Outrigger Control Block on Both Side

Emergency Stop Switch

Electric Main Control Panel and Local Controller

Pneumatic Solenoid Valve Type PTO Control

Stroke Changeover Switch

---

### OPTIONAL

Boom	Twin Wall Pipe
	Auto Lubrication
	Working Light
Outrigger	One Side Support (OSS) System
	Rear Outrigger Auxiliary Fuel Tank
Hopper	Pipe Storage Bracket on One Side Rear Outrigger
	Cover
	Safety Device
Platform	Central Manual Lubrication
	Vibrator
Paint	Aluminum Platform
	Spare Tire Storage Bracket
	Customized Color

Note) For more optional item not mentioned above please consult the manufacture.

# ECP53CS-5

## DIMENSIONS

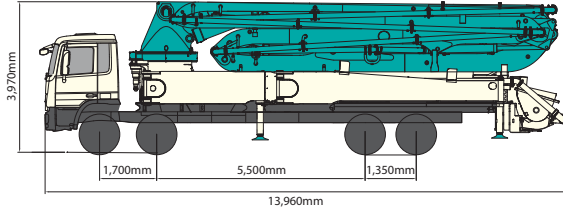

Front Axle Payload 14,300kg

Rear Axle Payload 24,800kg

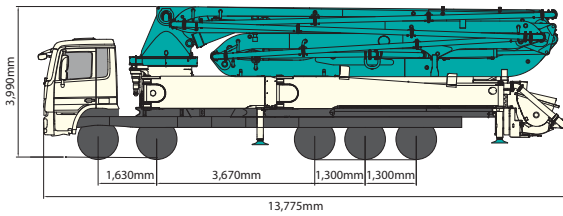

Front Axle Payload 12,200kg

Rear Axle Payload 26,400kg

\* Weight and dimension figures here are subject to change on various chassis option and additional axle application etc.

## WORKING RANGE

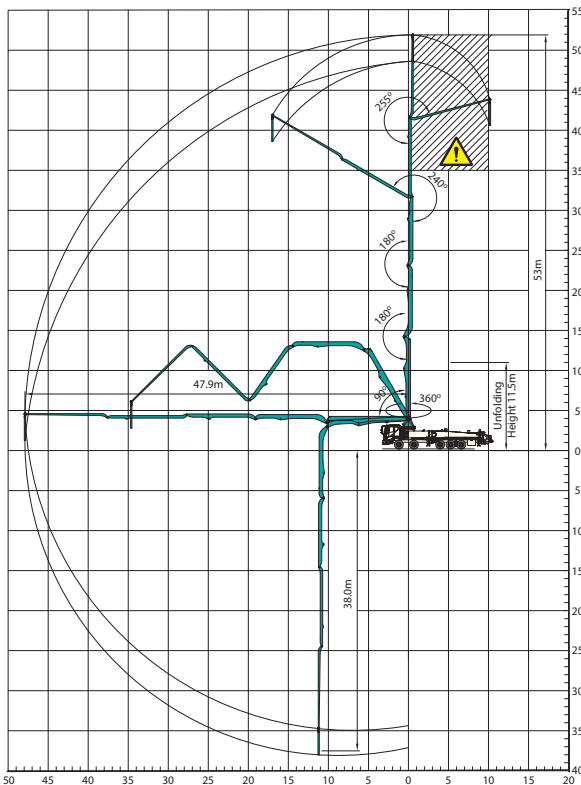

Don't use in caution area

UNIT : m

## PUMP

Pump Cell	2116
Control System	Closed Free Flow Hydraulic
Main Pump	A4VG125X2
Concrete Cylinder (mm)	Dia.230
	Stroke 2,100
Drive Cylinder (mm)	Dia.140
	Stroke 2,100
Theoretical Concrete Output (m <sup>3</sup> /h)	160
Theoretical Concrete Pressure (bar)	85
Stroke No. (per minute)	30
Transfer Tube Type	S-Tube, S2018 (Dia. 200-180mm)
Hopper Volume (liter)	600

## BOOM

Folding Type	5 Stage RZ-folding
Slewing Angle	360deg.
Max. Vertical Reach	53m
Max. Horizontal Reach	47.9m
Max. Depth Reach	38m (incl. End Hose 3m)
Unfolding Height	11.5m
End Hose Length	3m
Delivery Pipe Dia.	125mm

## OUTRIGGER

Front Outrigger Type	Two Stage Swing-out
	Full Spread Width 9.9m
Rear Outrigger Type	One Stage Swing-out
	Full Spread Width 10.3m

## OUTRIGGER SPREAD

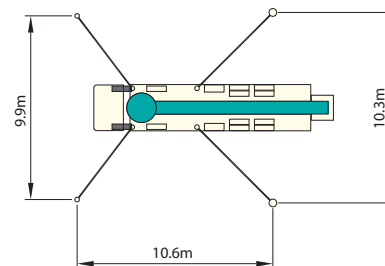

# EVERDIGM

EVERDIGM is large sized company with \$250M turnover providing customers across the world with its quality products. EVERDIGM has been working and growing based on the platform of advanced quality, professionalism and real satisfaction. Standing behind the customers taking responsibility at all stage its product life cycle is EVERDIGM's commitment.

## Build the Future

The spirit, "build the future", enables EVERDIGM to make a remarkable growth over 80 countries now. EVERDIGM offers the best value concrete pump which is key to build the brighter future for dealers and customers.

## Concrete Pump

- Free Flow Hydraulic System
- Boom Pump Ranging from 21M to 60M
- Placing Boom of Various Design
- High Pressure Trailer and Line Pump



### Truck Mounted Boom Pump Line-up (Max. Vertical Reach)

Unit : m

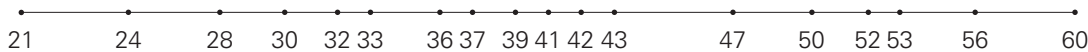

### Trailer Pump Line-up (Max. Concrete Pressure)

Unit : bar



### Line Pump Line-up (Max. Concrete Pressure)

Unit : bar



### Placing Boom Line-up (Max. Horizontal Reach)

Unit : m

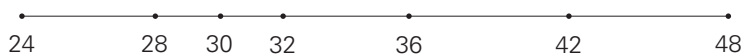

Distributed by

**Head Office & Factory**  
332-3, Janggwan-Ri, Jincheon-Eub, Chungcheongbuk-Do, Korea  
Tel\_+82-43-530-3300 Fax\_+82-43-530-3429

**Sales & Marketing Office**  
Room #1203, Woolim Lion's Valley 2, 680, Gasan-Dong, Geumcheon-Gu, Seoul, Korea  
Tel\_+82-2-801-0800 Fax\_+82-2-801-0899

@EVERDIGM Corp. Printed in Korea

